

## Preparation

**Part Number: PT747-30120****Kit Contents**

Item #	Quantity Req.	Description
1	1	Applique, RR Bumper

**Hardware Bag Contents**

Item #	Quantity Req.	Description
1		

**Additional Items Required For Installation**

Item #	Quantity Req.	Description
1		

**Conflicts**

None
------

**Recommended Tools**

<b>Personal &amp; Vehicle Protection</b>	<b>Notes</b>
None	
<b>Special Tools</b>	<b>Notes</b>
Squeegee	4" (3M™Gold)
Low Friction Sleeve	3M SA-1
Surface Thermometer	Infrared Non-contact
Heat Gun	Master Heat Gun HG-301A or equivalent
<b>Installation Tools</b>	<b>Notes</b>
Lint Free Rags	
Spray Bottle	For wetting agent
<b>Special Chemicals</b>	<b>Notes</b>
Cleaner	VDC approved cleaner and cleaning method
Wetting Agent Note: Solution depends upon ambient temperature of the part and the vehicle surface. If it is difficult to remove bubbles with a squeegee, add one more ml. of shampoo.	Johnson's Baby Shampoo mixed in one liter of water: At 65°F add 2 ml. shampoo At 70°F add 3 ml. shampoo At 80°F add 3.5 ml shampoo At 90°F add 4 ml. shampoo At 100°F add 5 ml. shampoo

**General Applicability**

All GS & GS-F models
----------------------

**Recommended Sequence of Application**







Item #	Accessory
1	

\*Mandatory

**Vehicle Service Parts** (may be required for reassembly)

Item #	Quantity Req.	Description
1		

**Legend**

	<b>STOP:</b> Damage to the vehicle may occur. Do not proceed until process has been complied with.
	<b>OPERATOR SAFETY:</b> Use caution to avoid risk of injury.
	<b>CAUTION:</b> A process that must be carefully observed in order to reduce the risk of damage to the accessory/vehicle and to ensure a quality installation.
	<b>TOOLS &amp; EQUIPMENT:</b> Used in Figures calls out the specific tools and equipment recommended for this process.
	<b>REVISION MARK:</b> This mark highlights a change in installation with respect to previous issue.
	<b>SAFETY TORQUE:</b> This mark indicates that torque is related to safety.

## Procedure

---

Care must be taken when installing this accessory to ensure damage does not occur to the vehicle. The installation of this accessory should follow approved guidelines to ensure a quality installation.



These guidelines can be found in the "Accessory Installation Practices" document.

This document covers such items as:-

- Vehicle Protection (use of covers and blankets, cleaning chemicals, etc.).
- Safety (eye protection, rechecking torque procedure, etc.).
- Vehicle Disassembly/Reassembly (panel removal, part storage, etc.).
- Electrical Component Disassembly/Reassembly (battery disconnection, connector removal, etc.).

Please see your Lexus dealer for a copy of this document.

### 1. Prepare the Vehicle.

-  (a) The part and vehicle surface temperature must be maintained between 65°F and 90°F for optimum installation. Store the parts flat at room temperature in a clean dry place.
-  (b) Clean the entire application surface to remove grease and wax. Clean the entire area with a VDC approved cleaner and cleaning method.
- (c) Wipe the cleaned surface with a clean, dry, lint-free cloth.

### 2. Install the Rear Bumper Applique.

- (a) Place the part face down on a clean flat surface. Remove the entire liner (Fig. 2-1).

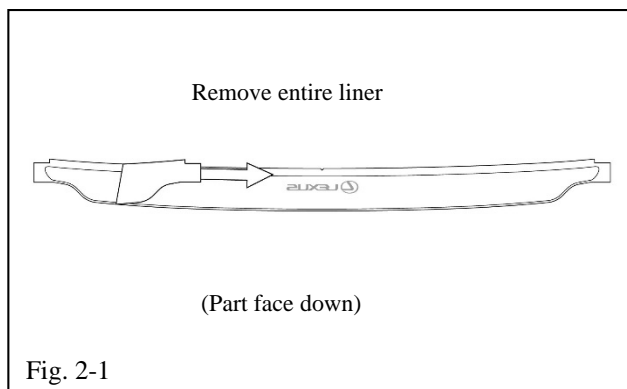

## Procedure

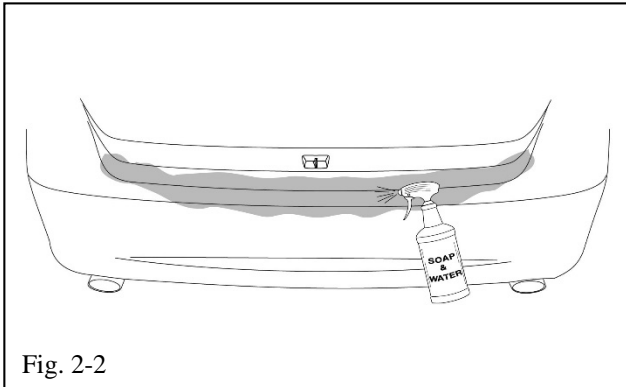

Fig. 2-2

- STOP** (b) Spray the bumper with a wetting agent (Fig. 2-2).

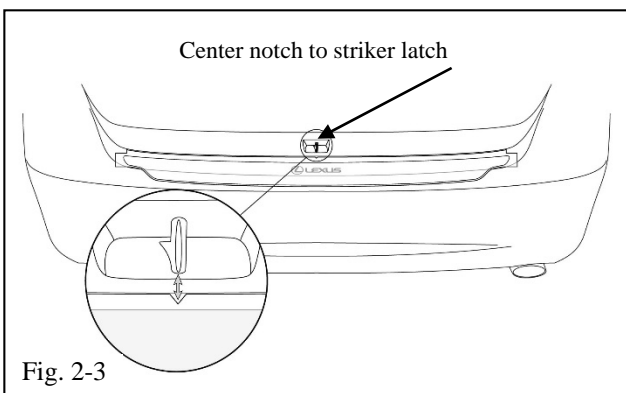

Fig. 2-3

- STOP** (c) Align the center notch directly below the striker latch opening and the leading edge of the premask along the ridge of the bumper. Be sure not to roll the part over the ridge. Do not smooth the part by hand (Fig. 2-3).

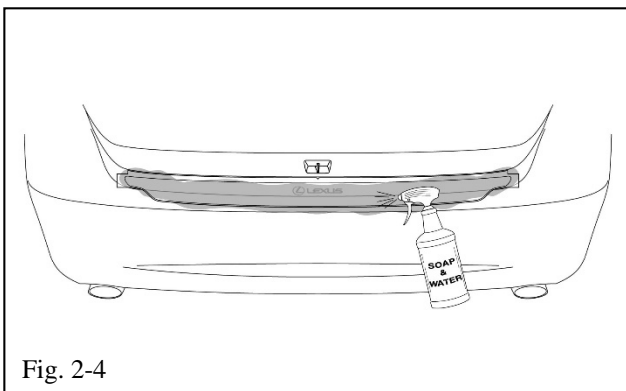
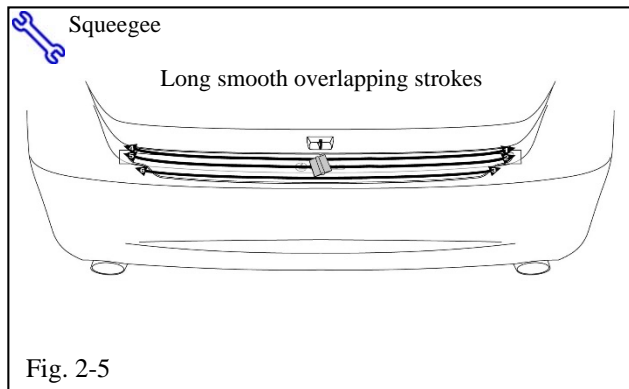

Fig. 2-4

- (d) Spray the premask with wetting agent (Fig. 2-4).

## Procedure



(e) Use long, smooth overlapping strokes with the squeegee from the center outwards of the horizontal section and begin to wrap the part over the bumper (Fig. 2-5).

(1) Do not use excessive force as it may cause creasing of the protector.

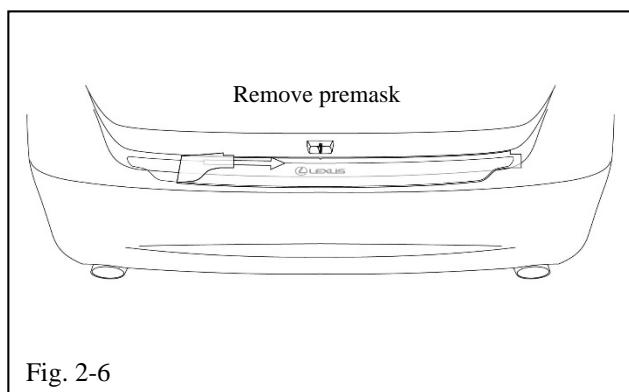

(2) Carefully remove the premask paper 180° against itself prior to squeegeeing the final wrap area (Fig. 2-6).

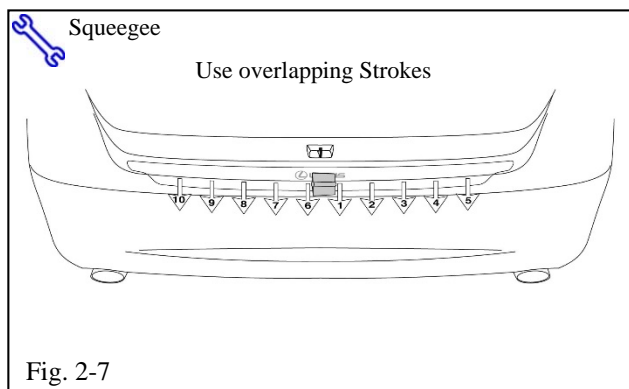

(f) Use a sharp squeegee with a protective sleeve and make smooth, overlapping downward strokes from the center outwards of the final wrap area or the vertical section (Fig. 2-7).

(g) Dry off the vehicle with a clean lint free rag.

Checklist - these points **MUST** be checked to ensure a quality installation.

Check:

Look For:

Accessory Function Checks

- Proper adhesion – Visual
-   Proper adhesion – Physical
  
- Proper alignment – Cross-Car

Look for bubbles, loose and lifting edges.

With light pressure rub hand over top of part and if crackling sound occurs, re-squeegee. If bubbles cannot be worked out to the nearest edge, replace part.

The part must be centered within bumper +/-3mm.

Vehicle Appearance Check

- After accessory installation and removal of protective cover(s), perform a visual inspection.

Ensure no damage (including scuffs and scratches) was caused during the installation process.  
(For PPO installations, refer to TMS Accessory Quality Shipping Standard.)